

Transmisión de la energía

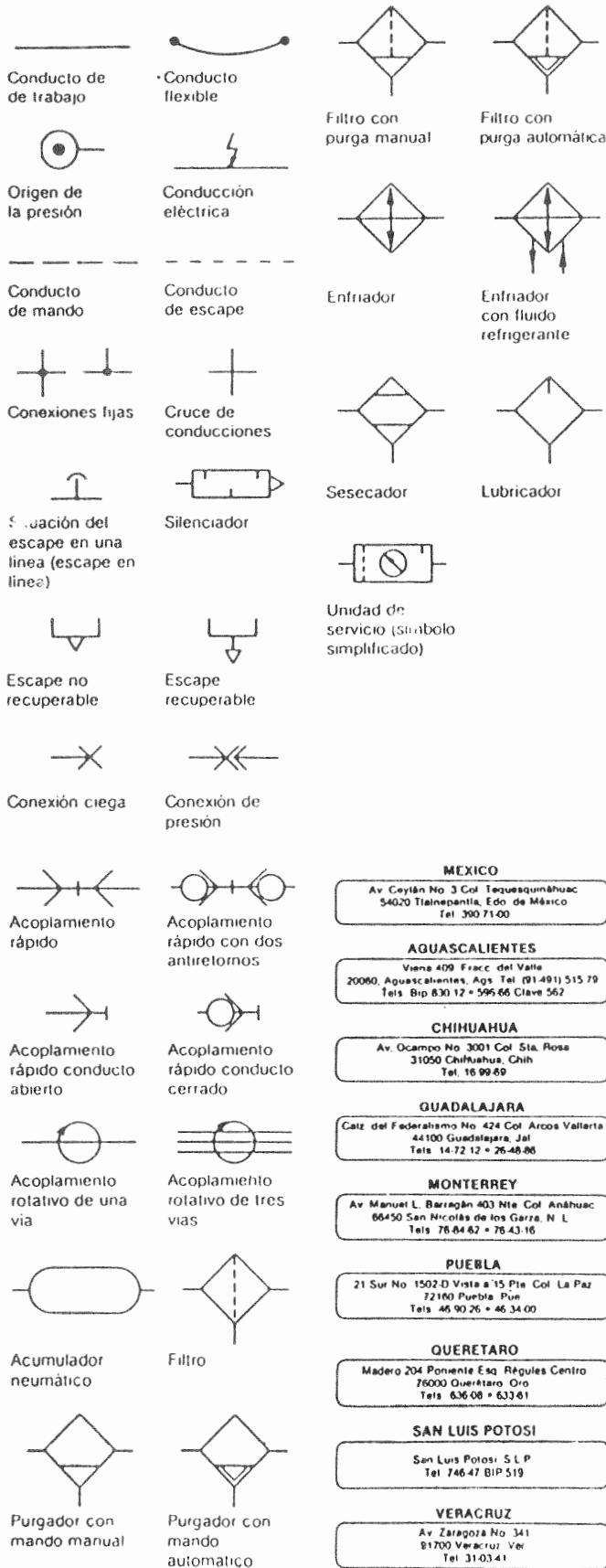

MEXICO Av. Ceylán No. 3 Col. Tequesquihúnc 54020 Tlalnepantla, Edo. de México Tel. 300 71-00
AGUASCALIENTES Viena 409 Fracc. del Valle 20060 Aguascalientes, Ags. Tel. (91-491) 515 79 Tels. Bip. 830 12 + 595-66 Clave 562
CHIHUAHUA Av. Ocampo No. 3001 Col. Sta. Rosa 31050 Chihuahua, Chih. Tel. 16 99 69
QUADALAJARA Catz del Federalismo No. 424 Col. Arcos Vallarta 44100 Guadalajara, Jal. Tels. 14 72 12 + 26 48 86
MONTERREY Av. Manuel L. Barragán 403 Nte. Col. Anáhuac 66450 San Nicolás de los Garza, N. L. Tels. 78 84 82 + 78 43 16
PUEBLA 21 Sur No. 1502-D Vista a 15 Pta. Col. La Paz 72160 Puebla, Pue. Tels. 46 90 26 + 46 34 00
QUERETARO Madero 204 Poniente Esq. Regules Centro 76000 Querétaro, Oro Tels. 636 08 + 633 61
SAN LUIS POTOSI San Luis Potosí, S. L. P. Tel. 746 47 BIP 519
VERACRUZ Av. Zaragoza No. 341 91700 Veracruz, Ver. Tel. 3103 41

Elementos de mando

Elementos mecánicos

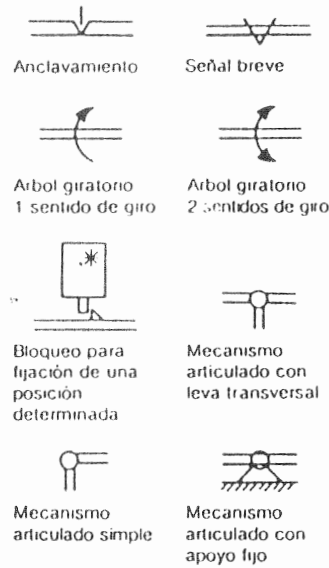

Manuales

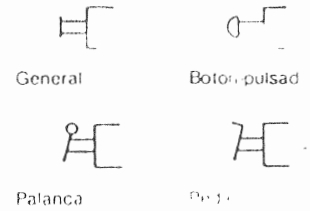

Mecánicos

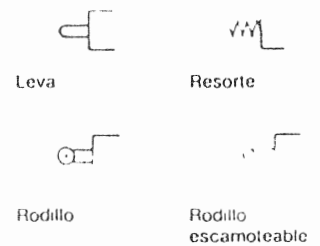

Por presión

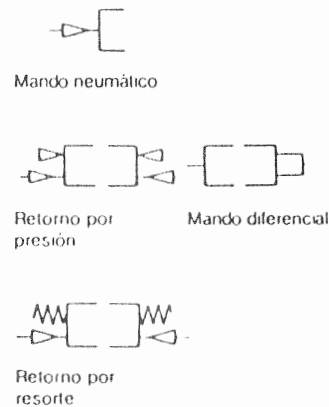

Eléctricos

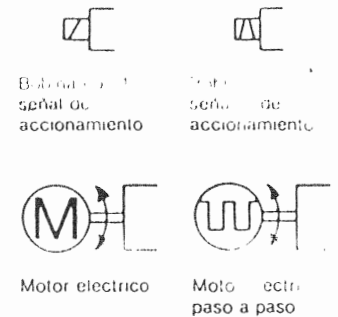

Acciones de mando especiales

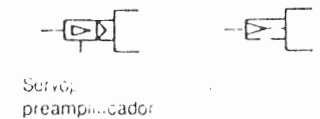

* = Símbolo no estandarizado

Combinados

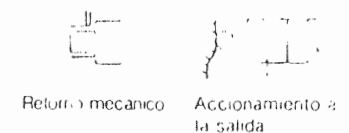
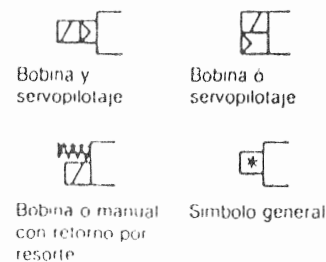

Transformación

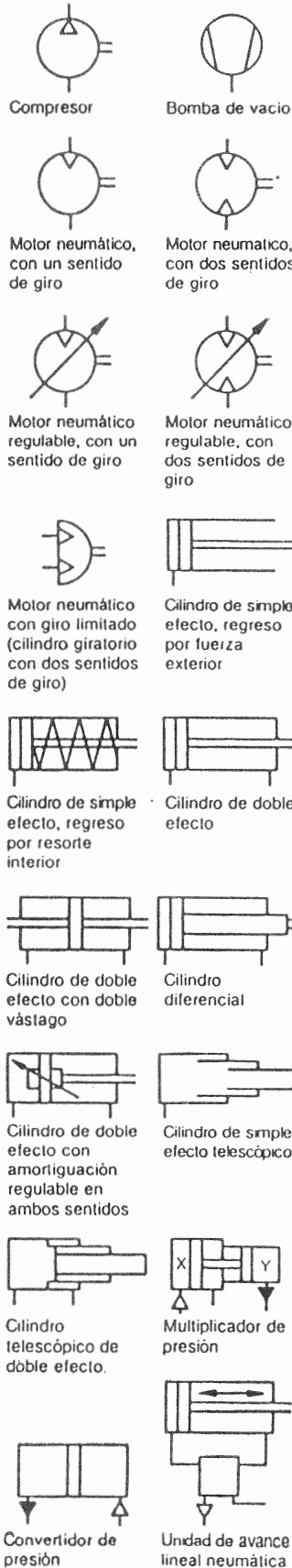

Válvulas

Válvulas de paso

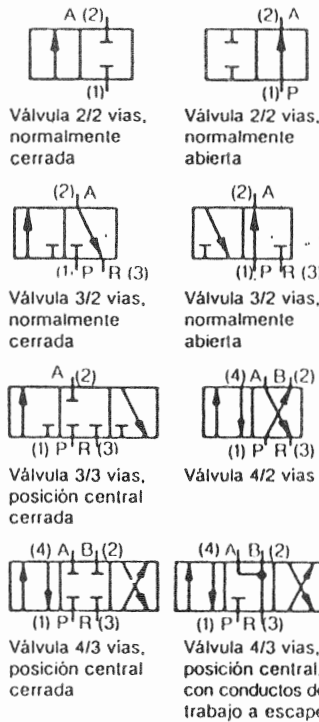

Válvulas de control de flujo

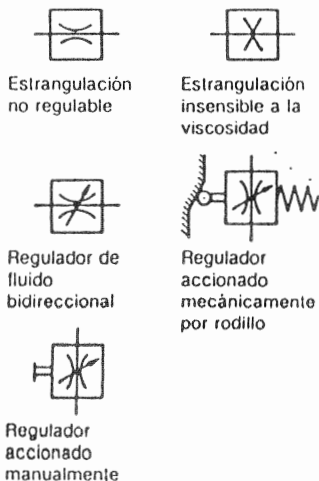

Válvula de cierre

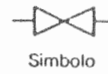

Válvulas reguladoras de presión

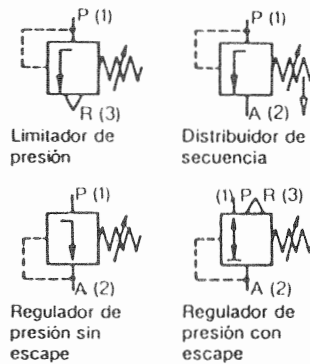

Válvulas de bloqueo

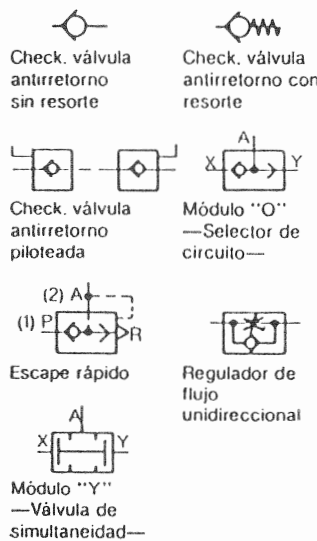

Detectores

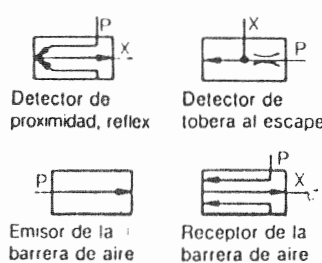

* = Símbolo no estandarizado

Otros símbolos

Instrumentos de medición

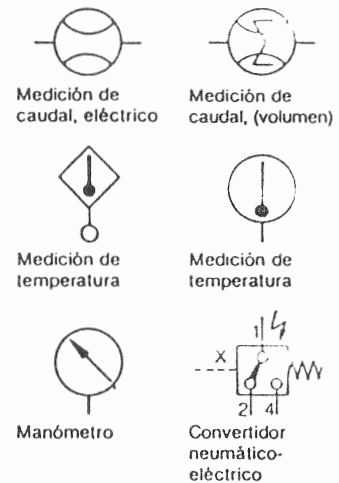

ISO STANDARD 5599/II

Denominación de los acoplamientos

A, B, C (2, 4, 6)	Utilizaciones
P (1)	Presión de alimentación
R, S, T (3, 5, 7)	Escapes
L	Escape de fluido
Z, Y, X (12; 14, 16)	Pilotajes

Símbolos lógicos

